

Tebis Application software

TL202A V 1.x Lighting, Shutter and Ventilation
Lighting functions

	Product reference	Product designation
	TXB202A	2-output module 4A 230V~ embedded

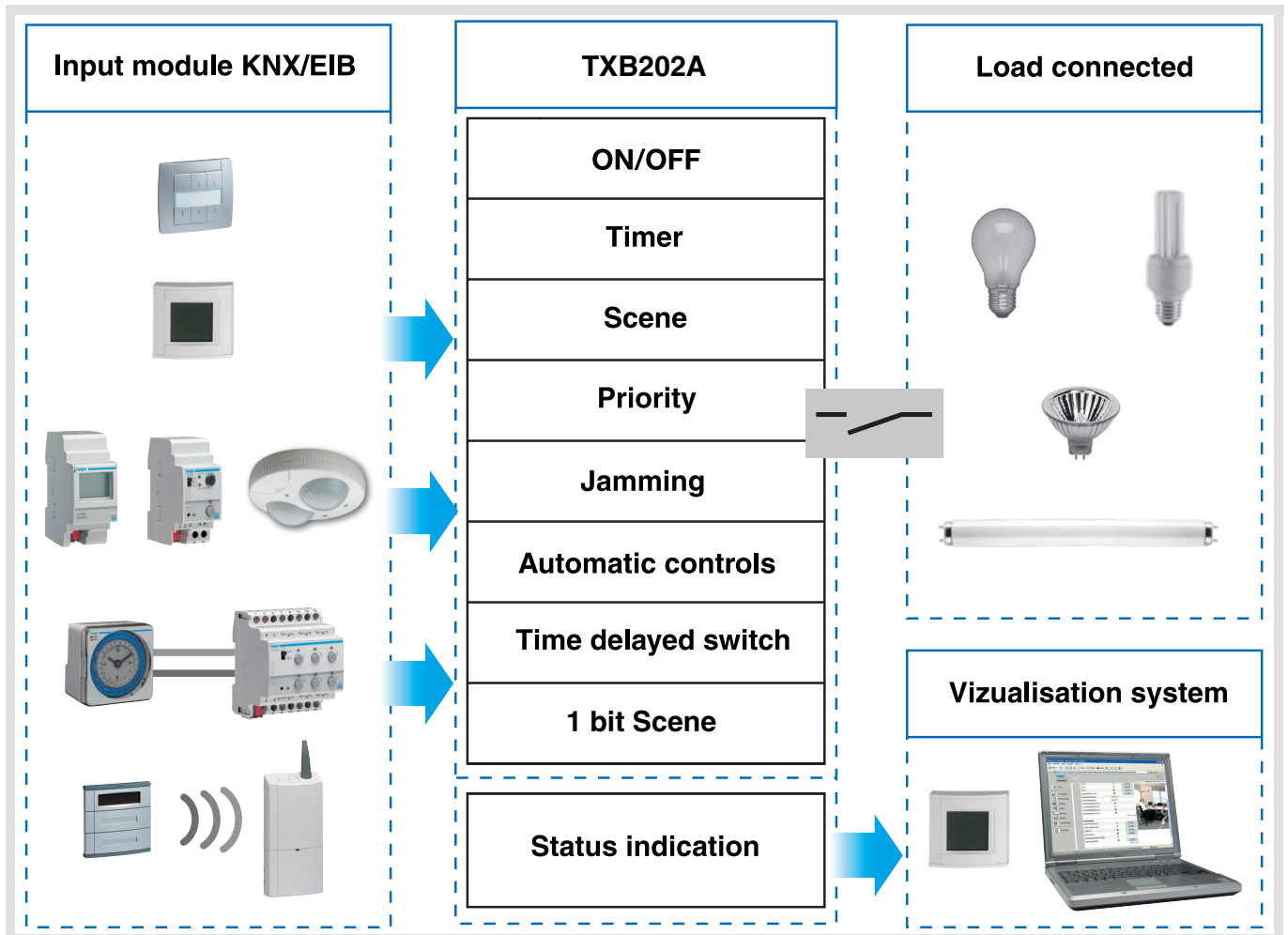

Summary

1. Presentation of the Lighting functions of the TL202A application	2
2. Configuration and parameters of the Lighting functions	3
2.1 General parameters.....	3
2.2 Objects list.....	4
2.3 Functions description.....	4
3. Main characteristics	15
4. Physical addressing	15

1. Presentation of the Lighting functions of the TL202A application

The TL202A application software allows each output to be individually configured for Lighting, Shutter or Ventilation applications.

The main functions of the Lighting application are the following :

■ ON/OFF

The ON/OFF function allows ON or OFF switching of a lighting circuit.
The command may come from switches, pushbuttons or automatic controls.

■ Status indication

The Status indication function displays the status of the output contact.
It allows a toggle function to be created by sending the status indication to each pushbutton of the group.

■ Timer

The Timer function allows ON or OFF switching of a lighting circuit for an adjustable time.
Depending on the timer operation selected, the output may be delayed for ON or OFF. The timer can be interrupted before the end of the delay time. An adjustable cut-OFF pre-warning indicates the end of the delay time by inverting the status of the output for 1 sec.

■ Time limited toggle switch

The Time delayed switch function combines a toggle function and a cut-off delay.
Pressing briefly a pushbutton inverts the output. If the output is ON, it switches automatically to OFF after a programmable delay time (energy savings).
Application : lighting of attics, cellars, sheds, etc.

■ Priority

The Priority function allows overriding an output to a definite status, ON or OFF.
This command has the highest priority. No other command is taken into consideration if a priority is active. Only a priority end command enables again the other commands.
Application : maintaining a lighting ON for safety reasons.

■ Jamming

The Jamming function allows locking an output in its current status.
This command has priority, but at a lower level than the Priority function. Jamming forbids any action until a jamming end command is sent.
The jamming duration can be delayed.

■ Scene

The Scene function allows grouping a set of outputs. These outputs can be put in a parameterisable predefined status.
Pressing one single pushbutton activates a scene.
Each output may be integrated in 32 different scenes.

■ Timer and automatic controls

The Timer and automatic controls function allow the outputs to be controlled by :

- Timer functions : Timer/toggle change over, Timer, Switching delay, Tripping delay, Switching and tripping delay,
- Automatic control functions : Authorization, logical AND or OR combinations.

■ Manual mode

The Manual mode isolates the product from the bus.
In this mode, it is possible to override manually each output.

2. Configuration and parameters of the Lighting functions

2.1 General parameters

■ ETS version selection

This parameter allows the presentation of the parameters to be optimised according to the ETS version used. Go to the ETS Version screen and select the required version : ETS2 or ETS3.
Default value : ETS3.

■ Select function

Go to the General screen and select Lighting.

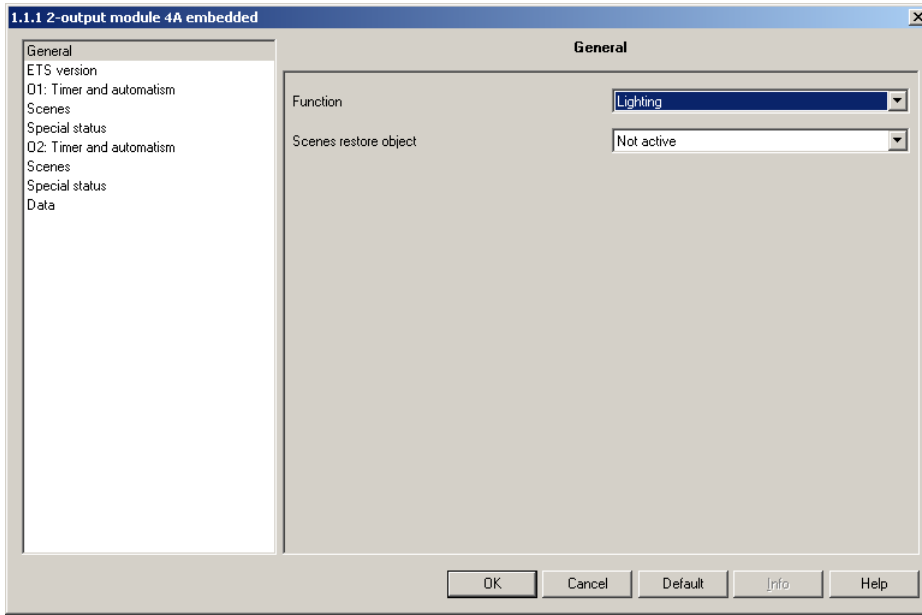

Screen 1

■ Other parameters

Designation	Description	Values
Scenes restore object (see also Scene function)	If the value is Active, the values linked with the scenes at the last download are restored when receiving this object.	Inhibited, Authorized. Default value : Inhibited.

2.2 Objects list

Number	Name	Object Function	Length	C	R	W	T	U	Priority
0	Output 1	ON/OFF	1 bit	C	R	W	-	U	Low
1	Output 1	Timer	1 bit	C	R	W	-	U	Low
2	Output 1	Priority	2 bit	C	R	W	-	U	Low
3	Output 1	Scene	1 Byte	C	R	W	-	U	Low
4	Output 1	Status indication	1 bit	C	R	-	T	U	Low
5	Output 2	ON/OFF	1 bit	C	R	W	-	U	Low
6	Output 2	Timer	1 bit	C	R	W	-	U	Low
7	Output 2	Priority	2 bit	C	R	W	-	U	Low
8	Output 2	Scene	1 Byte	C	R	W	-	U	Low
9	Output 2	Status indication	1 bit	C	R	-	T	U	Low
12	Output 1	Jamming	1 bit	C	R	W	-	U	Low
15	Output 1	Time delayed remote switch	1 bit	C	R	W	-	U	Low
16	Output 2	Jamming	1 bit	C	R	W	-	U	Low
19	Output 2	Time delayed remote switch	1 bit	C	R	W	-	U	Low

2.3 Functions description

■ ON/OFF function and status indication

The ON/OFF function allows the output to be switched ON or OFF using the ON/OFF object. The status of the output depends on the activation of other functions and of the associated parameters : priority, output type, automatic control, scene, etc. The status of the output is indicated on the bus by the Status indication object.

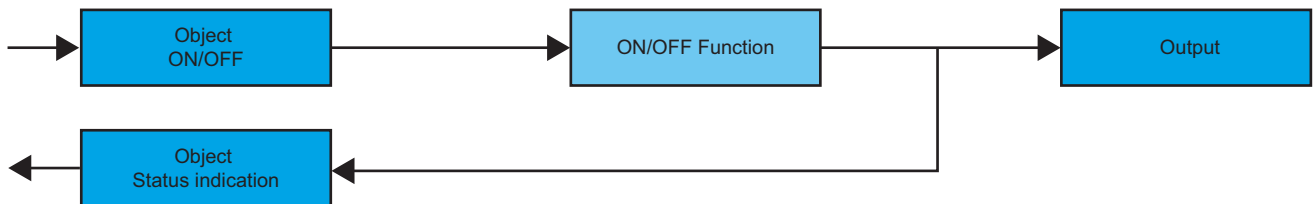

■ Timer function

The Timer function allows ON or OFF switching of a lighting circuit for an adjustable time. The function is started by the Timer object.

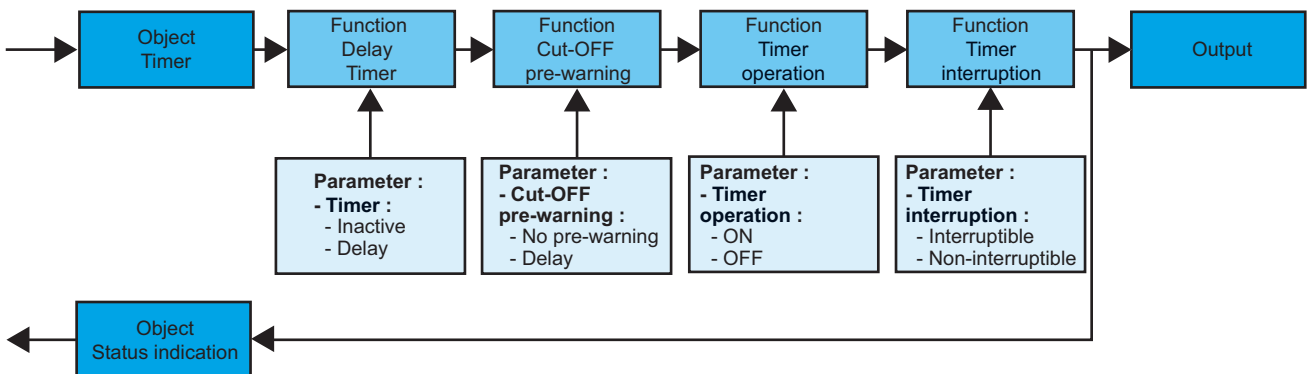

→ Parameters

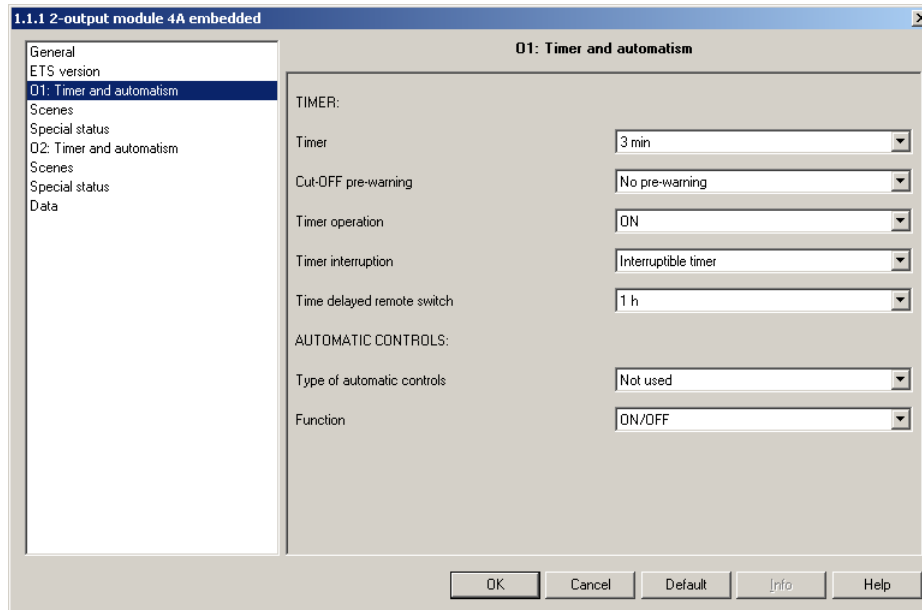

Screen 2

Designation	Description	Values
Timer	This parameter defines the length of the time delay.	Inhibited, Range [0.5 s 24 h]* Default value : 3 min.
Cut-OFF pre-warning (in ON operation)	When the pre-warning is active, the output switches to OFF for 1 sec. The value of the parameter defines the time before the end of the delay time, when the pre-warning will be applied.	No pre-warning, 15 s, 30 s, 1 min. Default value : No pre-warning.
Timer operation	This parameter defines whether the delay time triggers an ON or an OFF status.	ON, OFF Default value : ON.
Timer interruption	This parameter allows or not the interruption of the timer when the associated pushbutton is pressed for a long time.	Interruptible timer, Non-interruptible timer, Default value : Interruptible timer.

* Setting range [0.5 s 24 h]

0.5 s, 1 s, 2 s, 3 s, 5 s, 10 s, 15 s, 20 s, 30 s, 40 s, 45 s, 50 s, 1 min, 1 min 15 s, 1 min 30 s, 2 min, 2 min 30 s, 3 min, 4 min, 5 min, 6 min, 7 min, 8 min, 9 min, 10 min, 11 min, 12 min, 13 min, 14 min, 15 min, 20 min, 30 min, 40 min, 50 min, 1 h, 1 h 30 min, 2 h, 2 h 30 min, 3 h, 3 h 30 min, 4 h, 5 h, 6 h, 12 h, 24 h.

Note :

- Timer commands repeated n times during the first ten seconds after the beginning of the delay time multiply the duration of the delay time by n times the value of the Timer parameter
- A command given 10 sec after the beginning of the delay time restarts the timer only once

■ Time limited toggle switch function

The Time limited toggle switch function allows a toggle with a settable switch-off delay time to be created (energy savings). This function is started by the Time limited toggle switch object.

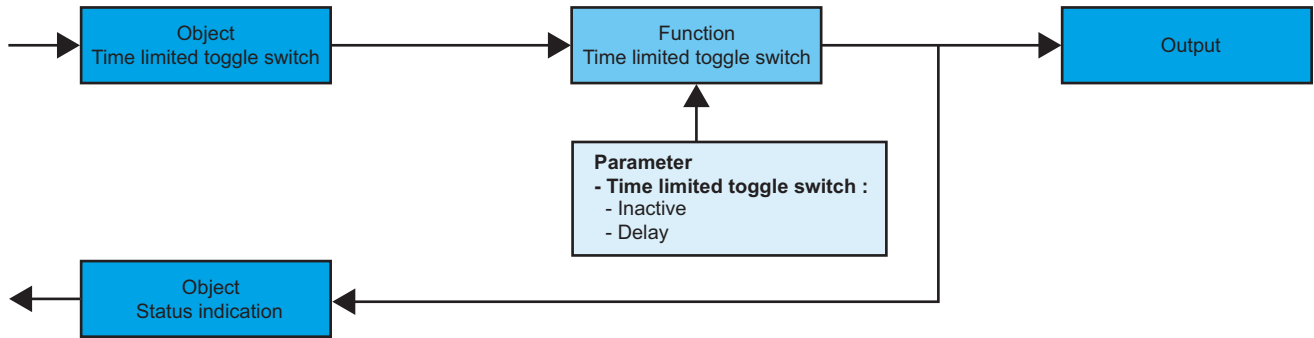

→ Parameters setting screen : see "Screen 2".

→ Parameter

Designation	Description	Values
Time limited toggle switch	This parameter defines the duration of the switch-off delay time.	Inhibited, Range [0.5 s 24 h]* Default value : 1 h.

* Setting range [0.5 s 24 h]

0.5 s, 1 s, 2 s, 3 s, 5 s, 10 s, 15 s, 20 s, 30 s, 40 s, 45 s, 50 s, 1 min, 1 min 15 s, 1 min 30 s, 2 min, 2 min 30 s, 3 min, 4 min, 5 min, 6 min, 7 min, 8 min, 9 min, 10 min, 11 min, 12 min, 13 min, 14 min, 15 min, 20 min, 30 min, 40 min, 50 min, 1 h, 1 h 30 min, 2 h, 2 h 30 min, 3 h, 3 h 30 min, 4 h, 5 h, 6 h, 12 h, 24 h.

■ Timer and Automatic controls functions

The Timer and automatic controls function allow the outputs to be controlled by :

- Timer functions : Timer/toggle change over, Timer, Switching delay, Tripping delay, Switching and tripping delay.
- Automatic control functions : Authorization, logical AND or OR combinations.

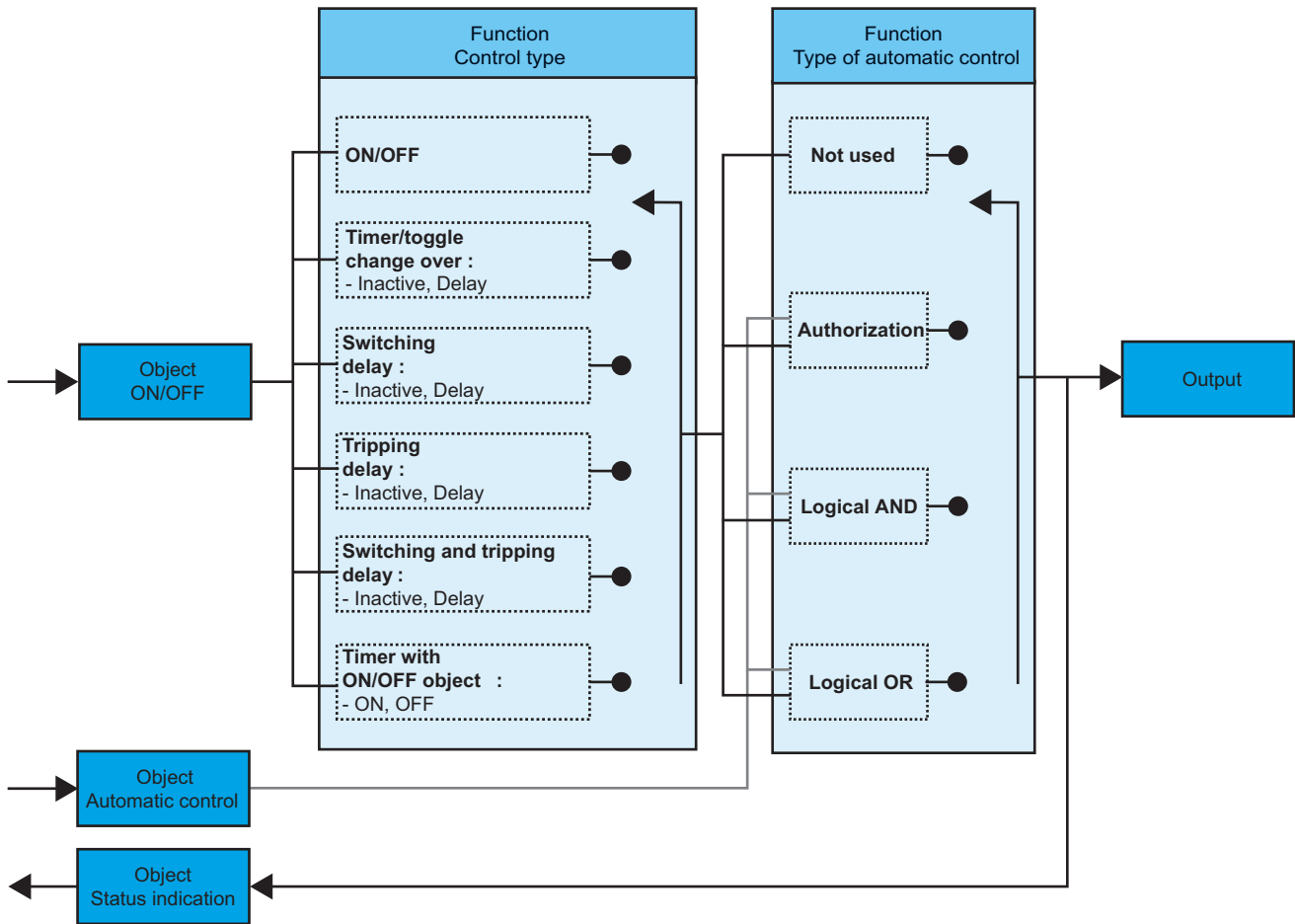

→ Parameters setting screen : see "Screen 2"

→ Parameters

The status of the output depends on the combination of the parameters Type of automatic control and Control type.

Type of automatic control	Control type	Operation	Parameters
Not used (default value)	ON/OFF (default value)	The output is controlled directly. The Automatic control object is ignored.	
	Switching delay	The output is delayed when switching. The Automatic control object is ignored.	Switching delay : Inhibited, [0 s 24 h]* Default value : 3 min
	Tripping delay	The output is delayed when tripping. The Automatic control object is ignored.	Switching delay : Inhibited, [0 s 24 h]* Default value : 3 min
	Switching and tripping delay	The output is delayed when switching and when tripping. The Automatic control object is ignored. The switching and tripping delay times may be different.	Switching delays : Inhibited, [0 s 24 h]* Default value : 3 min
	Timer with ON/OFF object	The output is delayed for ON or for OFF. The Automatic control object is ignored.	Time switch delay : Inhibited, [0 s 24 h]* Default value : 3 min Timer operation : ON, OFF Default value : ON
Authorization	Timer/toggle change over	The output is controlled directly by the ON/OFF object if the value of the Automatic control object is 1. The output is delayed for ON or for OFF if the value of the Automatic control object is 0.	Time switch delay : Inhibited, [0 s 24 h]* Default value : 3 min Timer operation : ON, OFF Default value : ON
	Switching delay	The output is delayed when switching if the value of the Automatic control object is 1. The commands are not taken into consideration if the value of the Automatic control object is 0.	Switching delay : Inhibited, [0 s 24 h]* Default value : 3 min
	Tripping delay	The output is delayed when tripping if the value of the Automatic control object is 1. The commands are not taken into consideration if the value of the Automatic control object is 0.	Switching delay : Inhibited, [0 s 24 h]* Default value : 3 min
	Switching and tripping delay	The output is delayed when switching and when tripping if the value of the Automatic control object is 1. The commands are not taken into consideration if the value of the Automatic control object is 0.	Switching delays : Inhibited, [0 s 24 h]* Default value : 3 min
	Timer with ON/OFF object	The output is delayed if the value of the Automatic control object is 1. The commands are not taken into consideration if the value of the Automatic control object is 0.	Time switch delay : Inhibited, [0 s 24 h]* Default value : 3 min Timer operation : ON, OFF Default value : ON

Type of automatic control	Control type	Operation	Parameters
Logical AND	ON/OFF	The output is the result of the logical AND between the value of the ON/OFF object and the value of the Automatic control object.	
	Switching delay	The output is the result of the logical AND between the value of the ON/OFF object delayed when switching and the value of the Automatic control object.	Switching delay : Inhibited, [0 s 24 h]* Default value : 3 min
	Tripping delay	The output is the result of the logical AND between the value of the ON/OFF object delayed when tripping and the value of the Automatic control object.	Switching delay : Inhibited, [0 s 24 h]* Default value : 3 min
	Switching and tripping delay	The output is the result of the logical AND between the value of the ON/OFF object delayed when switching and when tripping, and the value of the Automatic control object.	Switching delays : Inhibited, [0 s 24 h]* Default value : 3 min
	Timer with ON/OFF object	The output is the result of the logical AND between the value of the delayed ON/OFF object and the value of the Automatic control object.	Time switch delay : Inhibited, [0 s 24 h]* Default value : 3 min Timer operation : ON, OFF Default value : ON
Logical OR	ON/OFF	The output is the result of the logical OR between the value of the ON/OFF object and the value of the Automatic control object	
	Switching delay	The output is the result of the logical OR between the value of the ON/OFF object delayed when switching and when tripping, and the value of the Automatic control object.	Switching delay : Inhibited, [0 s 24 h]* Default value : 3 min
	Tripping delay	The output is the result of the logical OR between the value of the ON/OFF object delayed when switching and when tripping, and the value of the Automatic control object.	Switching delay : Inhibited, [0 s 24 h]* Default value : 3 min
	Switching and tripping delay	The output is the result of the logical OR between the value of the ON/OFF object delayed when switching and when tripping, and the value of the Automatic control object.	Switching delays : Inhibited, [0 s 24 h]* Default value : 3 min
	Timer with ON/OFF object	The output is the result of the logical OR between the value of the delayed ON/OFF object and the value of the Automatic control object	Time switch delay : Inhibited, [0 s 24 h]* Default value : 3 min Timer operation : ON, OFF Default value : ON

* Setting range [0 s 24 h]

0 s, 1 s, 2 s, 3 s, 5 s, 10 s, 15 s, 20 s, 30 s, 40 s, 45 s, 50 s, 1 min, 1 min 15 s, 1 min 30 s, 2 min, 2 min 30 s, 3 min, 4 min, 5 min, 6 min, 7 min, 8 min, 9 min, 10 min, 11 min, 12 min, 13 min, 14 min, 15 min, 20 min, 30 min, 40 min, 50 min, 1 h, 1 h 30 min, 2 h, 2 h 30 min, 3 h, 3 h 30 min, 4 h, 5 h, 6 h, 12 h, 24 h.

■ Priority function

The Priority function allows the outputs to be forced and maintained at a definite ON or OFF status imposed by the input. This function is started by the Priority object (EIS priority). Priority is the function with the highest priority. Only a priority end command ends the Priority and allows again the commands from the bus to be taken into consideration.

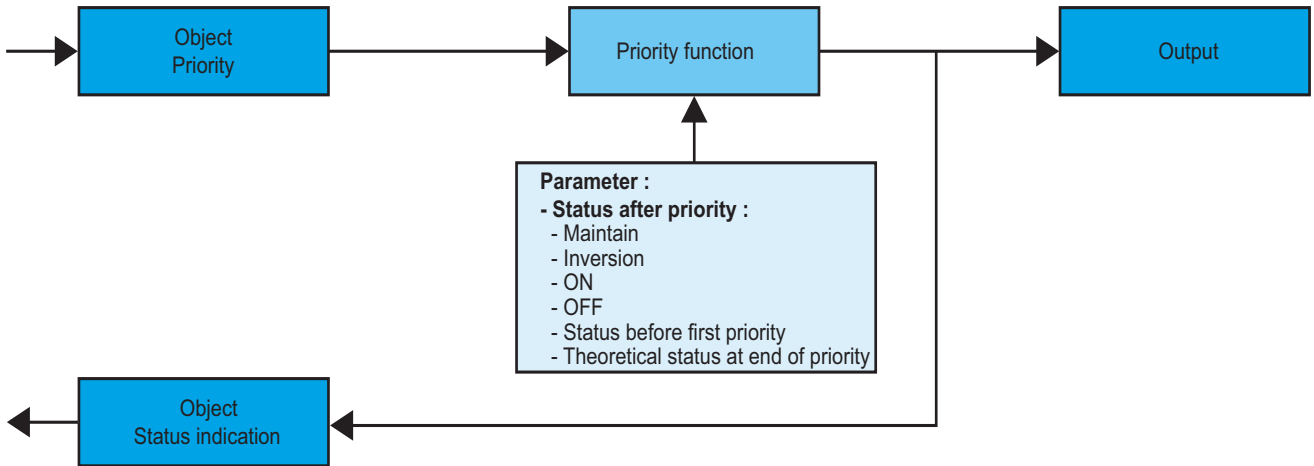

→ Priority function description (EIS priority).

Bit 1	Bit 0
Output behaviour	

Output behaviour	00 or 01 = Priority end 10 = OFF priority 11 = ON priority
------------------	--

→ Parameter

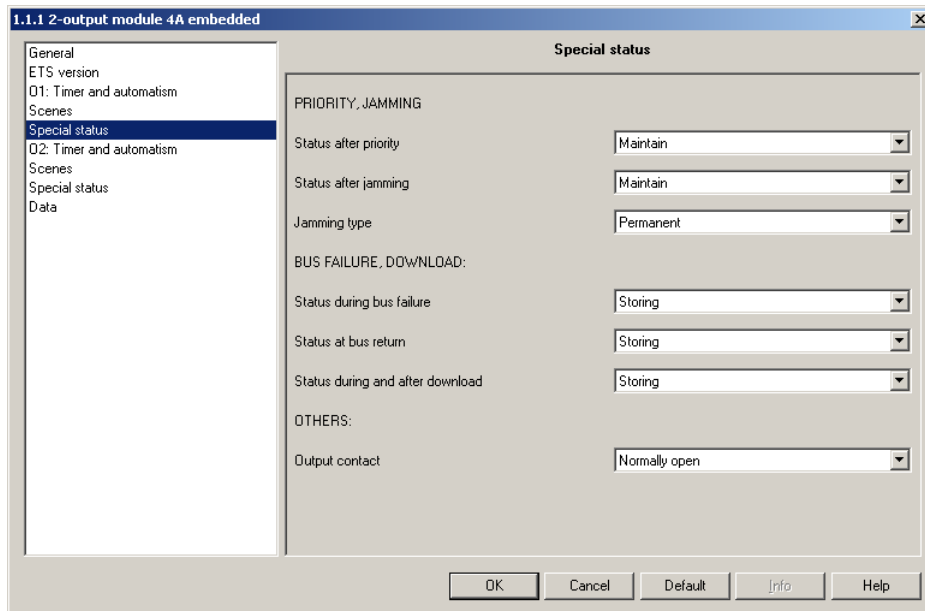

Screen 3

Designation	Description	Values
Status after priority	This parameter defines the output status to be applied at the end of the Priority.	Maintain, Inversion, ON, OFF, Status before first priority, Theoretical status at end of priority. Maintain : maintains the output at the status active during Priority. Inversion : inversion of the output status with regards to the status active during Priority (ON to OFF and OFF to ON). ON : switches the output to ON. OFF : switches the output to OFF. Status before first priority : switches the output to the status active before the Priority command. Theoretical status at end of priority : switches the output to the status that would be active if no Priority command had occurred. Default value : Maintain.

■ Jamming function

The Jamming function allows the outputs to be locked in their current status. This function is started by the Jamming object. The Jamming function is the function with the second highest priority after Priority. A Jamming end command ends the jamming and allows again taking the commands from the bus into consideration. A Priority command ends the Jamming.

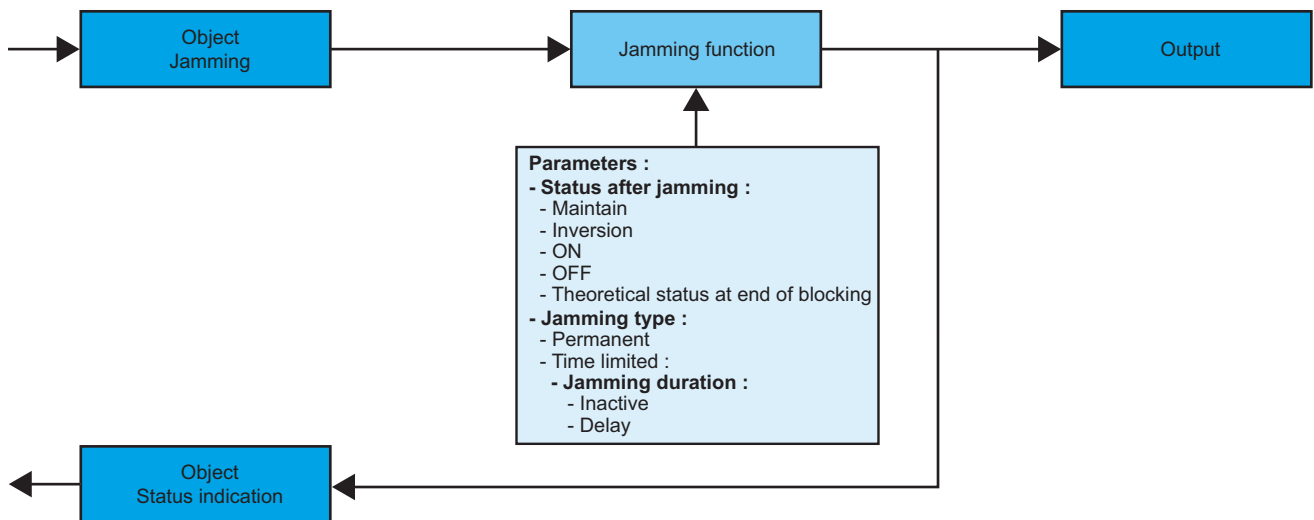

→ Parameters setting screen : see "Screen 3".

→ Parameters

Designation	Description	Values
Status after jamming	This parameter defines the output status to be applied at the end of the Jamming.	Maintain, Inversion, ON, OFF, Theoretical status at end of blocking. Maintain : maintains the output at the status active during Jamming. Inversion : inversion of the output status with regards to the status active during Jamming (ON to OFF and OFF to ON). ON : switches the output to ON. OFF : switches the output to OFF. Theoretical status at end of blocking : switches the output to the status that would be active if no Jamming command had occurred. Default value : Maintain.

Designation	Description	Values
Jamming type	This parameter defines whether Jamming is permanent or time-limited.	Permanent, Time limited. Time limited : Jamming is active for a parameterisable limited duration. Default value : Permanent.
Jamming duration**	This parameter defines the Jamming duration.	Inhibited, Range [0.5 s 24 h]* Default value : 1 h.

* Setting range [0.5 s 24 h]

0.5 s, 1 s, 2 s, 3 s, 5 s, 10 s, 15 s, 20 s, 30 s, 40 s, 45 s, 50 s, 1 min, 1 min 15 s, 1 min 30 s, 2 min, 2 min 30 s, 3 min, 4 min, 5 min, 6 min, 7 min, 8 min, 9 min, 10 min, 11 min, 12 min, 13 min, 14 min, 15 min, 20 min, 30 min, 40 min, 50 min, 1 h, 1 h 30 min, 2 h, 2 h 30 min, 3 h, 3 h 30 min, 4 h, 5 h, 6 h, 12 h, 24 h.

** This parameter is only visible when the Jamming type parameter has the value : Time limited.

■ Special statuses

The parameters grouped in this section allow defining the behaviour of the outputs in some special cases.

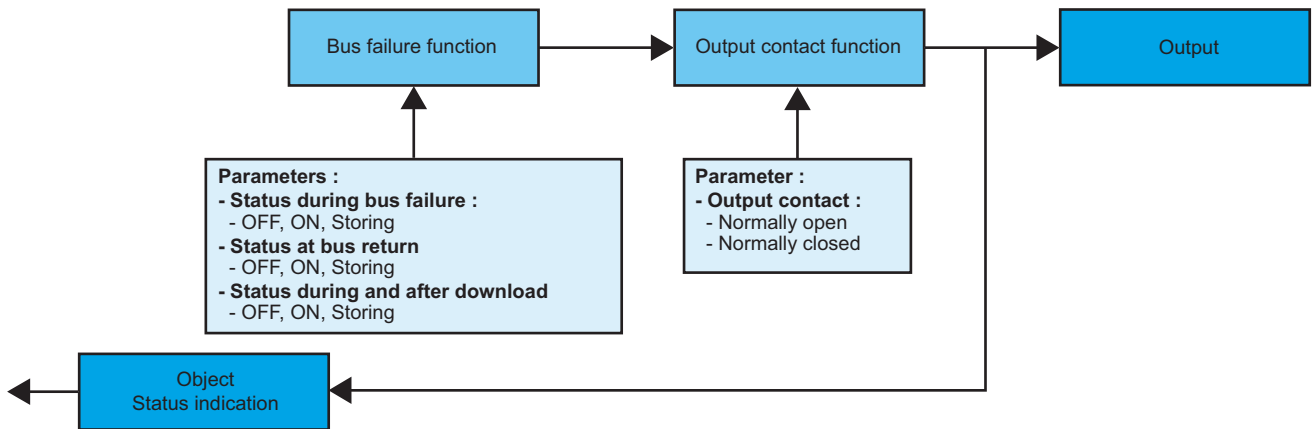

→ Parameters setting screen : see "Screen 3".

→ Parameters

Designation	Description	Values
Status during bus failure	This parameter defines the output status to be applied during Bus failure.	OFF, ON, Storing. Default value : Storing.
Status at bus return	This parameter defines the output status to be applied when the Bus returns.	OFF, ON, Storing. Default value : Storing.
Status during and after download	This parameter defines the output status to be applied during and after download.	OFF, ON, Storing. Default value : Storing.
Output contact	This parameter defines the contact type of the output.	Normally open, Normally closed. Default value : Normally open.

■ Scene function

A scene allows controlling a group of outputs. Each of the outputs of this group will be put in a status predefined for this scene. The group of outputs is created previously by establishing the link between the outputs that must belong to the scene and the pushbutton that will trigger the scene. Each output may be integrated in 32 different scenes. The status of each output may be defined by parameterising, by learning in the room using the pushbuttons of the installation or on the product.

A. Configuration and storing by means of parameterising

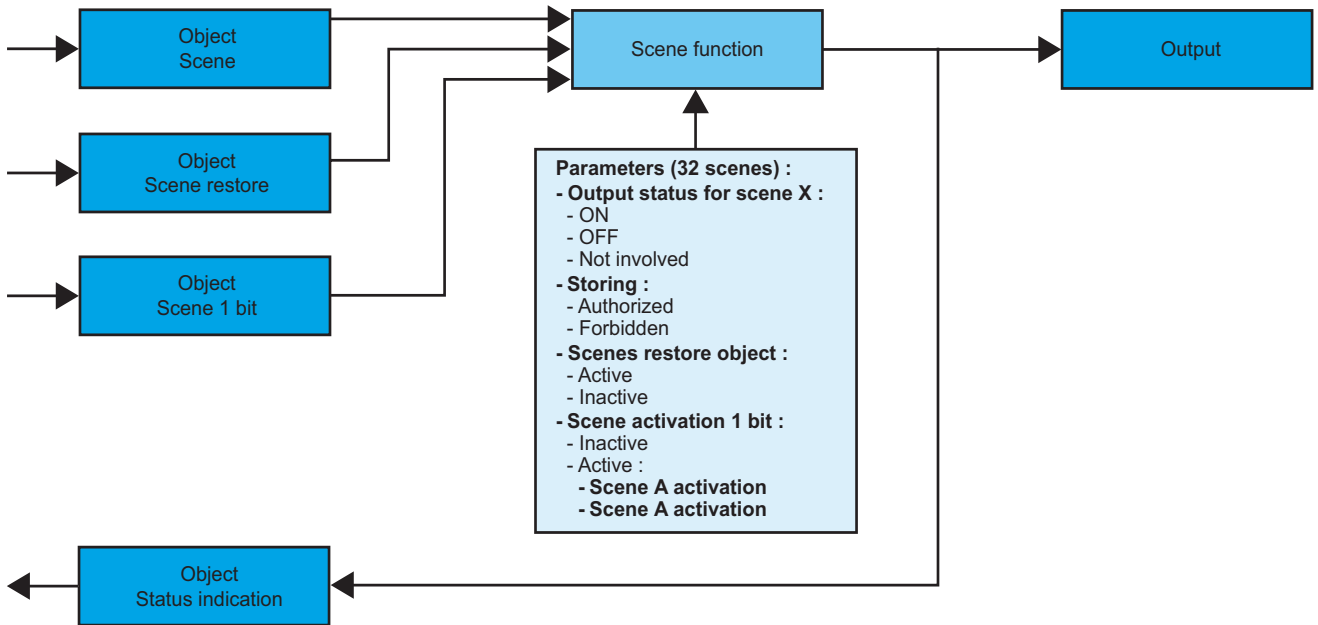

→ Description of scene object (1 byte)

7	6	5	4	3	2	1	0
Learn	X	Scene number					

→ Parameters

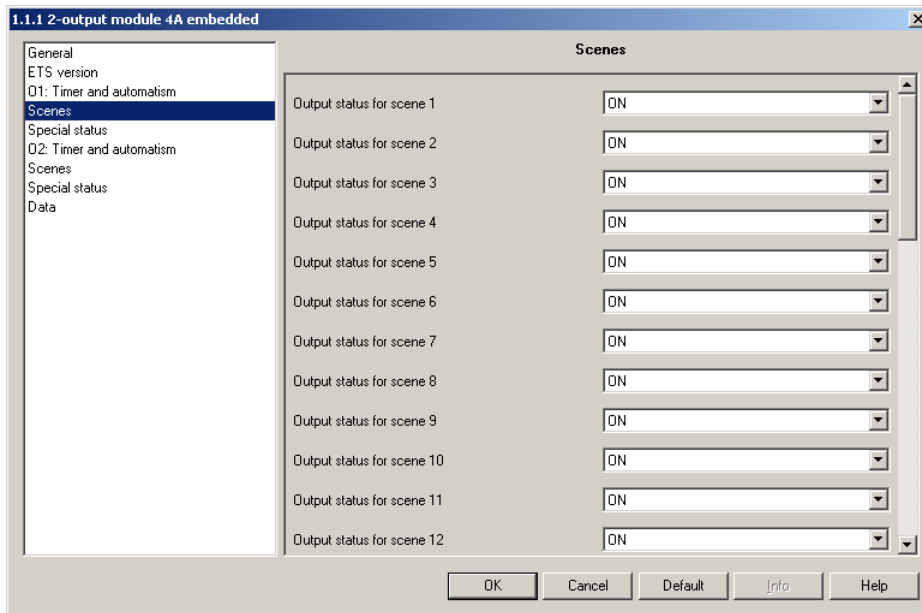

Screen 4

Designation	Description	Values
Output status for scene X	This parameter defines the status of the output linked with scene X.	ON, Stop, Not involved. Note : if the value of the parameter is Not involved, the scene will not influence this output. Default value : ON.
Storing	This parameter authorises or forbids the learning of the scene.	Authorized, Forbidden. Default value : Authorized.
Scene activation 1 bit	This parameter allows 2 scenes among the 32 possible ones to be activated, with the help of the object Scene 1 bit.	Not active, Active. Default value : Not active.
Scene A activation / Scene B activation*		No active scene, Scene 1 to scene 32. Default value : No active scene.

* These parameters only are visible if the Scene activation 1 bit parameter has the value : Active.

Note : a Scenes restore object, parameterised in the general screen, allows the values linked with the outputs to be restored at the last download (see paragraph "General parameters").

B. Learning and storing in the room

This procedure allows modifying and storing a scene by means of local action on the pushbuttons located in the room.

- Activate the scene pressing briefly on the room pushbutton that triggers the scene.
- Set the outputs to the desired status using the pushbuttons that control them individually.
- Store the status of the outputs pressing for more than 5 sec the room pushbutton that triggers the scene. The storage is indicated by the status inversion of the involved outputs for 3 sec.

C. Learning and storing on the product

This procedure allows modifying and storing a scene by means of local action on the pushbuttons located on the front side of the products. This procedure also allows an output to be removed from a scene (Not involved).

- Activate the scene pressing briefly on the room pushbutton that triggers the scene.
- Store the status of the outputs pressing for more than 5 sec the room pushbutton that triggers the scene.
The switching to the learning mode is indicated by the status inversion of the involved outputs for 3 sec.
- As soon as the indicators associated with the outputs blink slowly, press briefly and repeatedly the pushbuttons linked with the outputs to set the outputs to the desired status. The indicators associated with the outputs show the status chosen :
 - OFF if the value selected for the scene is OFF.
 - Red and continuously ON if the value selected for the scene is ON.
 - Red and quickly blinking if the value selected for the scene is Not involved.
- Store the status selected for this scene pressing for a time longer than 3 sec the pushbutton associated with the output. The storage is indicated by the return of the slow blinking of the indicators associated with the outputs.
- Repeat the previous step for each of the outputs of the scene.

3. Main characteristics

Max. number of group addresses	254
Max. number of links	255
Objects	15 total : 7 per lighting output 1 for scenes restoration

4. Physical addressing

To perform physical addressing or check for the presence of the bus, press briefly (less than 2 s) the pushbutton S1/Addr. Indicator Addr ON = bus present and product in physical addressing.

The product remains in physical addressing until the physical address is transmitted by ETS. Pressing a second time allows leaving the physical addressing mode.

