

Tebis Application software

TL215A V 2.x Dimming

	Product reference	Product designation
	TXA 215	Dimmer 1 x 1000W

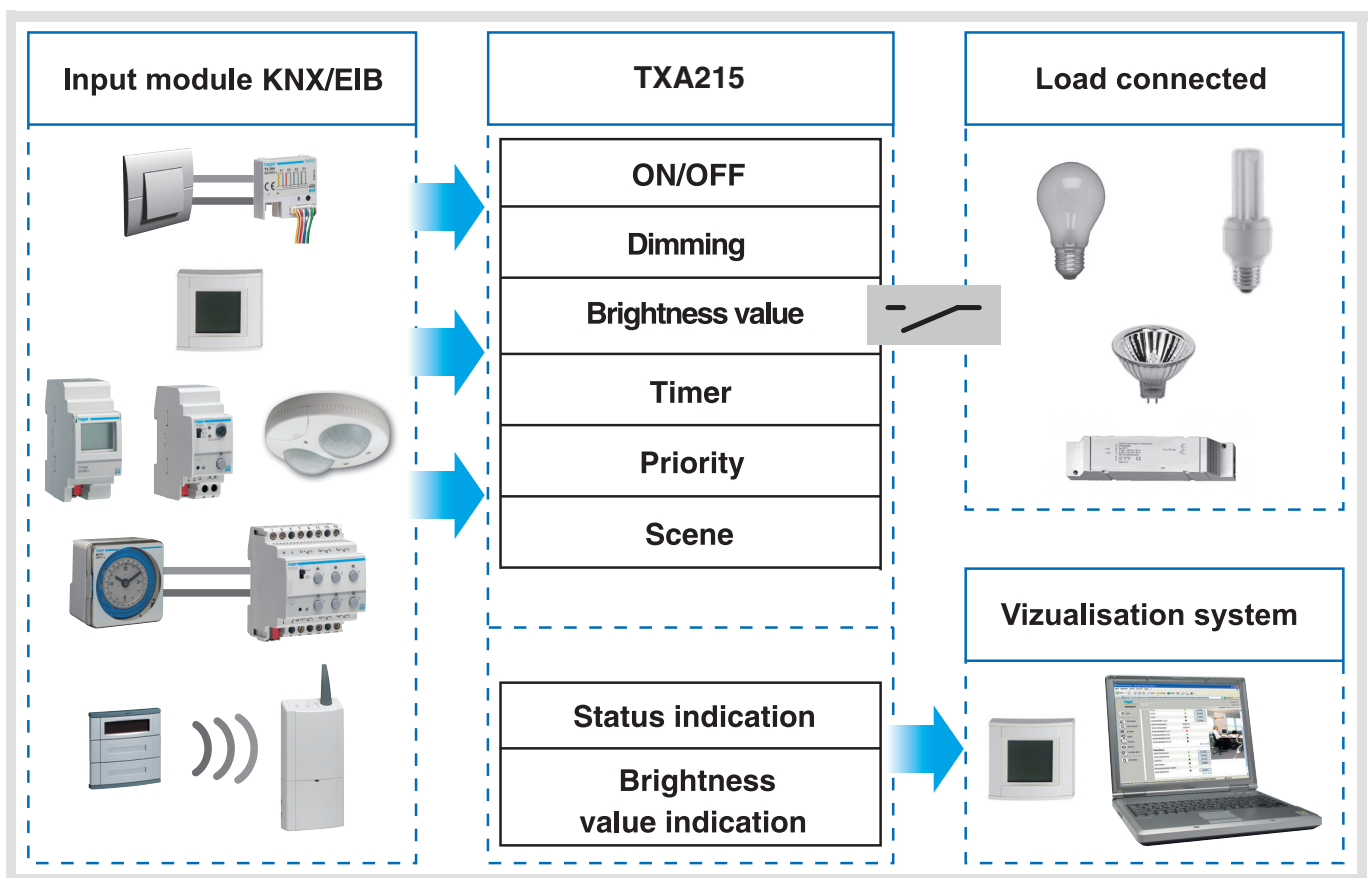

Summary

1. Presentation of the Dimming functions of the TL215A application	2
2. Configuration and parameters of the Dimming functions	3
2.1 General parameters.....	3
2.2 Objects list.....	4
2.3 Functions description.....	4
3. Main characteristics	14
4. Physical addressing	14

1. Presentation of the Dimming functions of the TL215A application

The TL215A application software allows the output to be configured for Dimming applications.
The main functions are the following :

■ ON/OFF

The ON/OFF function allows ON or OFF switching of a lighting circuit.

- ON : switching ON at the lighting level defined by parameters. The switching can be made gradually or instantaneously.
- OFF : lights out. The switching OFF can be made gradually or instantaneously.

The command may come from pushbuttons.

■ Relative or absolute dimming

The relative dimming allows increasing or decreasing the lighting level as long as a pushbutton is pressed down. The dimmer speed is settable.

The absolute dimming allows defining in % the lighting level to reach.

■ Timer

The Timer function allows ON or OFF switching of a lighting circuit for an adjustable time.

Depending on the timer operation selected, the output may be delayed for ON or OFF. An adjustable cut-OFF pre-warning indicates the end of the delay time by dividing the lighting level by two.

■ Priority

The Priority function allows overriding an output to an adjustable lighting level.

This command has the highest priority. No other command is taken into consideration if a priority is active. Only a priority end command enables again the other commands.

Application : maintaining a lighting ON for safety reasons.

■ Scene

The Scene function allows grouping a set of outputs. These outputs can be put in a parameterisable predefined status.

Pressing one single pushbutton activates a scene.

The dimmer speed to reach these lighting levels are adjustable.

■ Setting of minimum and maximum dimming values

This function allows defining minimum and maximum lighting levels for the output.

These values can be defined via an ETS parameter or directly on the front of the product.

■ Manual mode

The Manual mode isolates the product from the bus.

In this mode, the brightness of the lighting circuit can be forced locally.

In this mode, the following local settings are also possible :

- Switch ON speed
- Cut OFF speed
- Relative dimmer speed
- Minimum dimming value
- Maximum dimming value
- Brightness value and dimming speed for the 8 first scenes

These parameters can also be set in ETS. Local settings take over values downloaded excepted :

- Minimum dimming value.
- Maximum dimming value.

The parameter Relative dimming min/max values after download defines if these values should or not be taken into account.

2. Configuration and parameters of the Dimming functions

2.1 General parameters

■ ETS version selection

This parameter allows the presentation of the parameters to be optimised according to the ETS version used. Go to the ETS Version screen and select the required version : ETS2 or ETS3.

Default value : ETS3.

→ Parameters

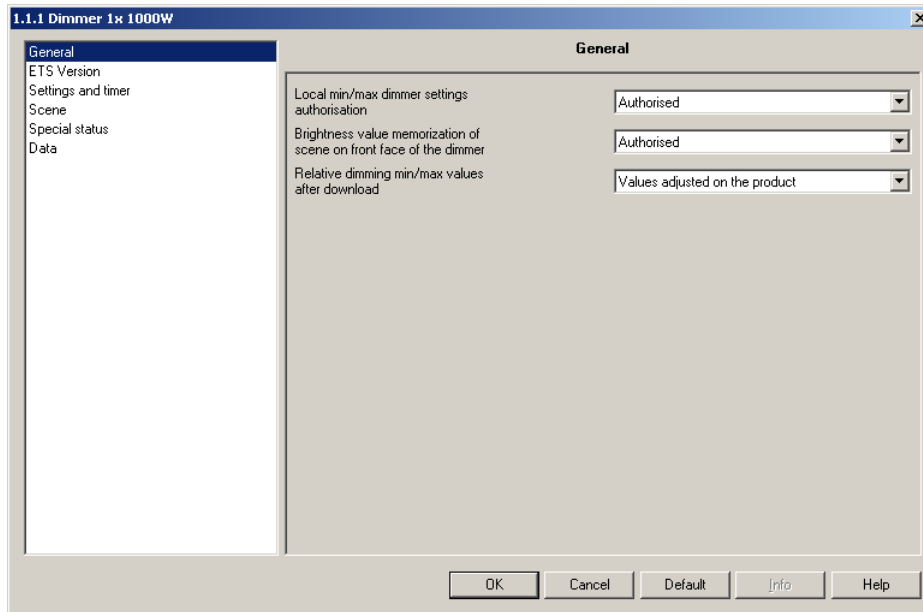

Screen 1

■ Setting of minimum and maximum dimming values

The relative dimming range can be defined on the product or via an ETS parameter.

■ Local settings

A 2 positions switch on the front side of the product allows selecting the following modes :

- Auto
- Manual

■ ETS parameters

In case of ETS downloading, the possibilities are :

- the limits set on the product are not modified.
- the limits set locally are replaced by the values on the parameters.

→ Parameters

Designation	Description	Values
Local min/max dimmer settings authorisation	This parameter allows or not taking into account the Min and Max switch position.	Forbidden, Authorized. Default value : Authorized.
Relative dimming min/max values after download	This parameter allows or not taking into account the dimming range limits defined with ETS.	Values adjusted on the product, Values settings in ETS Default value : Values adjusted on the product.

■ Scenes modification via long key-press (see also Scene function)

→ Parameter

Designation	Description	Values
Scenes modification via long key-press	This parameter authorises or forbids the local learning of the scene.	Forbidden, Authorized. Default value : Authorized.

2.2 Objects list

Nu...	Name	Object Function	Length	C	R	W	T	U	Priority
0	Output 1	ON/OFF	1 bit	C	R	W	-	U	Low
1	Output 1	Dimming	4 bit	C	R	W	-	U	Low
2	Output 1	Brightness value	1 Byte	C	R	W	-	U	Low
3	Output 1	Timer	1 bit	C	R	W	-	U	Low
4	Output 1	Priority	2 bit	C	R	W	-	U	Low
5	Output 1	Scene	1 Byte	C	R	W	-	U	Low
6	Output 1	Status indication	1 bit	C	R	-	T	U	Low
7	Output 1	Brightness value indication	1 Byte	C	R	-	T	U	Low

2.3 Functions description

■ ON/OFF function, status indication, and brightness value indication

The ON/OFF function allows the output to be switched ON or OFF using the ON/OFF object.

- ON : switching ON at the lighting level defined by parameters. The switching can be made gradually or instantaneously.
- OFF : lights out. The switching OFF can be made gradually or instantaneously.

The dimmer speed is settable.

The switching ON and switching OFF speed are defined by parameter for the ON/OFF function, the value of the parameters will also be used for the absolute dimming, timer and priority.

The output status and the lighting level are indicated on the bus by the brightness value indication object.

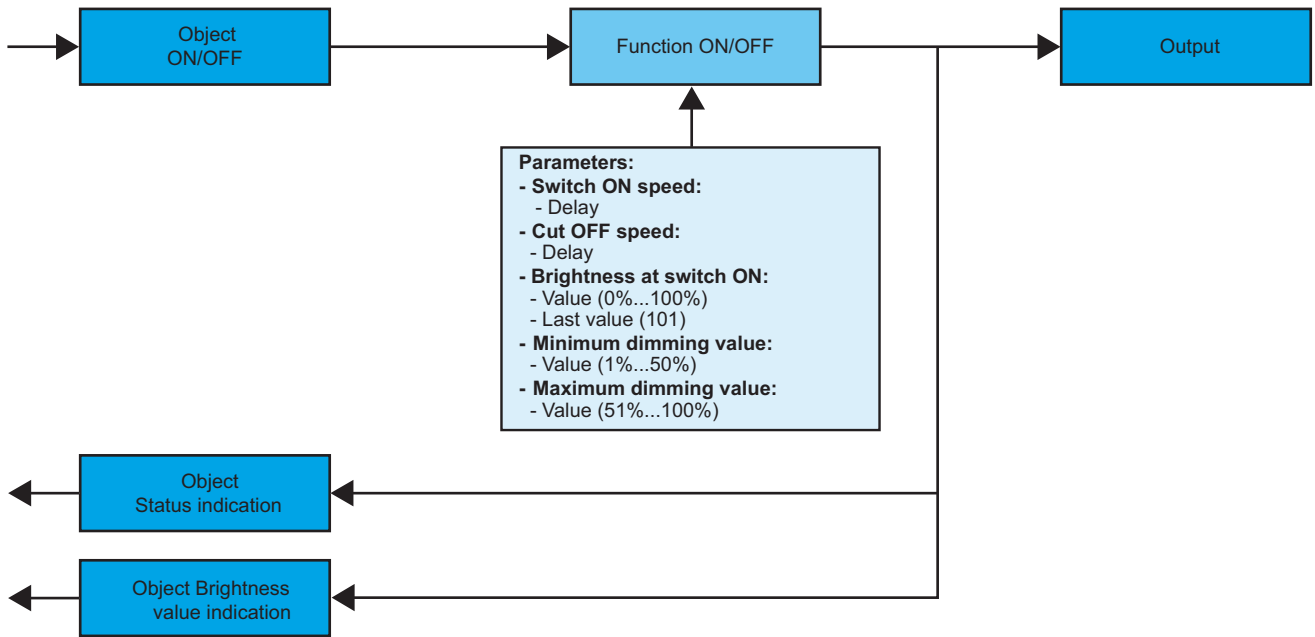

→ Operating way

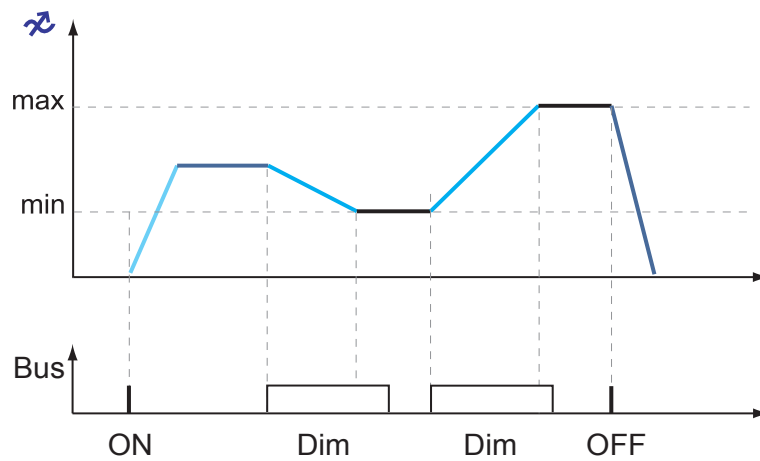

	Switch ON speed
	Relative dimmer speed
	Cut OFF speed
	Brightness at switching ON

→ Parameters

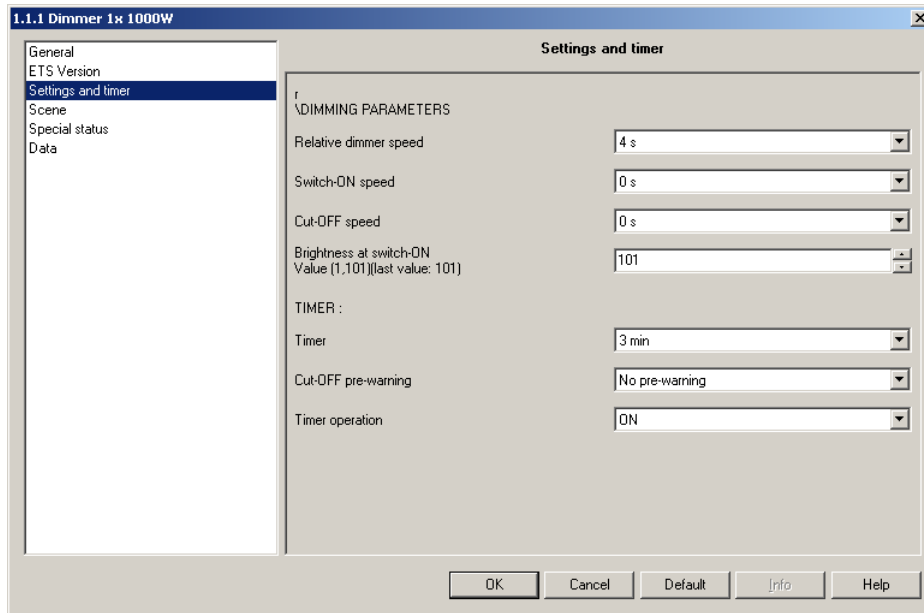

Screen 2

Designation	Description	Values
Switch ON speed	This parameter defines the dimming speed to reach the brightness level at switching ON.	0 s, 1 s, 2 s, 3 s, 4 s, 5 s, 6 s, 9 s, 15 s, 30 s, 60 s, 2 min, 5 min, 10 min, 20 min, 30 min. Default value : 0 s.
Cut OFF speed	This parameter defines the dimming speed at switching OFF.	0 s, 1 s, 2 s, 3 s, 4 s, 5 s, 6 s, 9 s, 15 s, 30 s, 60 s, 2 min, 5 min, 10 min, 20 min, 30 min. Default value : 0 s.
Brightness at switch ON	This parameter defines the brightness level at switching ON.	0 % to 100% by steps of 1%, 101 (last value). Default value : 101 (last value).
Minimum dimming value*	This parameter defines the minimum brightness level while dimming.	1 % to 50% by steps of 1%. Default value : 1%.
Maximum dimming value*	This parameter defines the maximum brightness level while dimming.	51 % to 100% by steps of 1%. Default value : 100%.

* These parameters are only visible if the parameter Relative dimming min/max values after download has the value : Values settings in ETS.

■ Dimming function

The dimming can be relative or absolute.

A. Relative dimming

The relative dimming allows increasing or decreasing the lighting level of the lighting circuit as long as a pushbutton is pressed down.

The relative dimming function is started by the Dimming object.

The dimmer speed is settable.

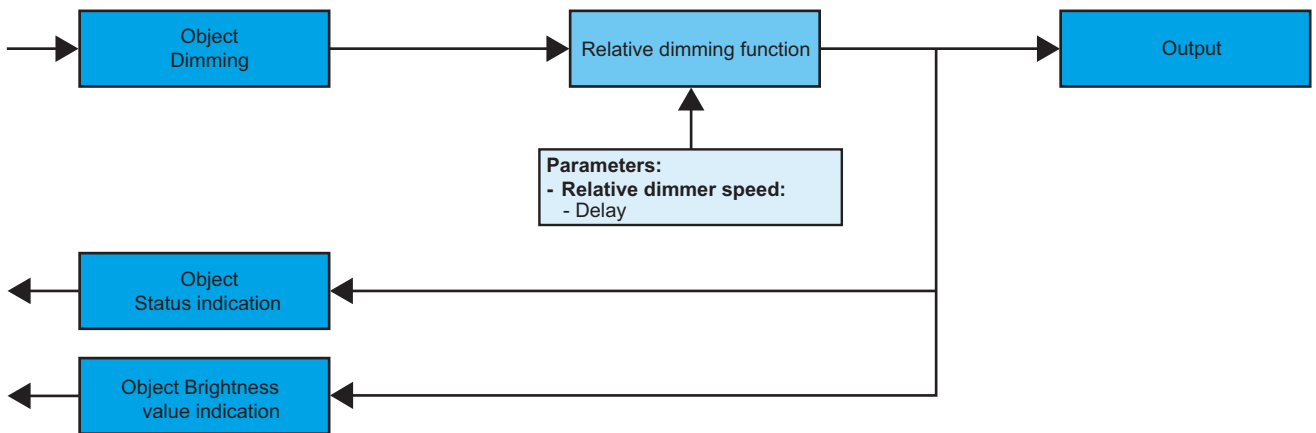

→ Parameters setting screen : see "Screen 2".

→ Parameter

Designation	Description	Values
Relative dimmer speed	This parameter defines the dimming speed to go from 0% level to 100% level.	1 s, 2 s, 3 s, 4 s, 5 s, 6 s, 9 s, 15 s, 30 s, 60 s. Default value : 4 s.

B. Absolute dimming

The absolute dimming function allows bringing the lighting circuit to a brightness level. The absolute dimming function is started by the brightness value object. The dimmer speed is settable (same values than for the ON/OFF function).

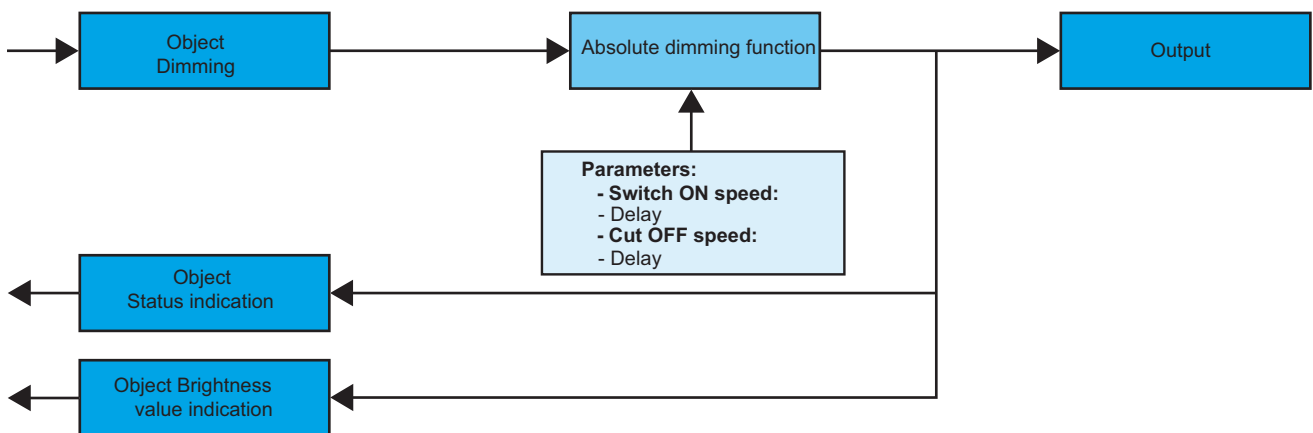

→ Parameters setting screen : see "Screen 2".

→ Parameters

Designation	Description	Values
Switch ON speed (similar to ON/OFF function)	This parameter defines the dimming speed to reach the brightness level at switching ON.	0 s, 1 s, 2 s, 3 s, 4 s, 5 s, 6 s, 9 s, 15 s, 30 s, 60 s, 2 min, 5 min, 10 min, 20 min, 30 min. Default value : 0 s.
Cut OFF speed (similar to ON/OFF function)	This parameter defines the dimming speed at switching OFF.	0 s, 1 s, 2 s, 3 s, 4 s, 5 s, 6 s, 9 s, 15 s, 30 s, 60 s, 2 min, 5 min, 10 min, 20 min, 30 min. Default value : 0 s.

■ Timer function

The Timer function allows ON or OFF switching of a lighting circuit for an adjustable time. The function is started by the Timer object. The dimmer speed is settable (same values than for the ON/OFF function).

Cut-OFF pre-warning (in ON operation) :

An adjustable cut-OFF pre-warning indicates the end of the delay time by dividing the lighting level by two.

The value of the parameter cut-OFF pre-warning defines the time before the end of the delay time, when the pre-warning will be applied.

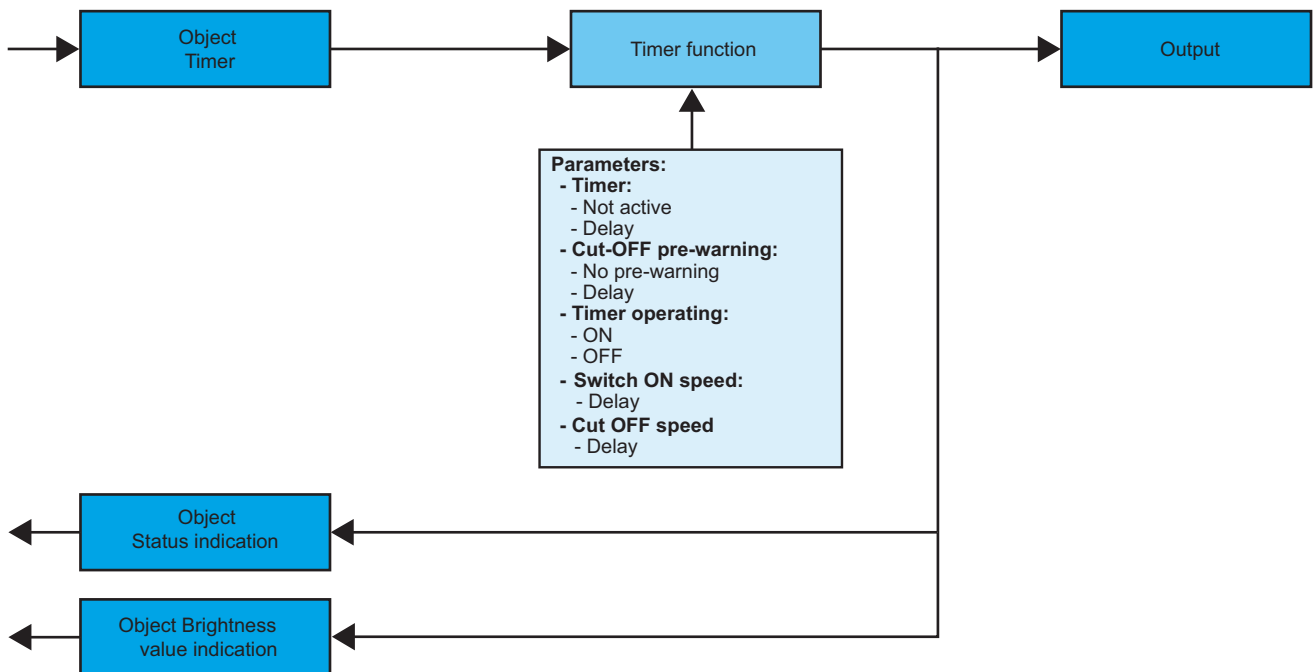

→ Parameters setting screen : see "Screen 2".

→ Parameters

Designation	Description	Values
Timer	This parameter defines the length of the time delay.	Inactive, Range [1 s 24 h]* Default value : 3 min.
Timer operation	This parameter defines whether the delay time triggers an ON or an OFF status.	ON, OFF Default value : ON.
Cut-OFF pre-warning	The value of the parameter defines the time before the end of the delay time, when the pre-warning will be applied.	No pre-warning, 15 s, 30 s, 1 min. Default value : No pre-warning.
Switch ON speed (similar to ON/OFF function)	This parameter defines the dimming speed to reach the brightness level at switching ON.	0 s, 1 s, 2 s, 3 s, 4 s, 5 s, 6 s, 9 s, 15 s, 30 s, 60 s, 2 min, 5 min, 10 min, 20 min, 30 min. Default value : 0 s.
Cut OFF speed (similar to ON/OFF function)	This parameter defines the dimming speed at switching OFF.	0 s, 1 s, 2 s, 3 s, 4 s, 5 s, 6 s, 9 s, 15 s, 30 s, 60 s, 2 min, 5 min, 10 min, 20 min, 30 min. Default value : 0 s.

* Setting range [1 s 24 h]

1 s, 2 s, 3 s, 5 s, 10 s, 15 s, 20 s, 30 s, 40 s, 45 s, 50 s, 1 min, 1 min 15 s, 1 min 30 s, 2 min, 2 min 30 s, 3 min, 4 min, 5 min, 6 min, 7 min, 8 min, 9 min, 10 min, 11 min, 12 min, 13 min, 14 min, 15 min, 20 min, 30 min, 40 min, 50 min, 1 h, 1 h 30 min, 2 h, 2 h 30 min, 3 h, 3 h 30 min, 4 h, 5 h, 6 h, 12 h, 24 h.

■ Priority function

The Priority function allows the output to be forced and maintained at a definite ON or OFF status imposed by the input. This function is started by the Priority object (EIS priority). The brightness on priority ON is settable. The dimmer speed is settable (same values than for the ON/OFF function). Priority is the function with the highest priority. Only a priority end command ends the Priority and allows again the commands from the bus to be taken into consideration.

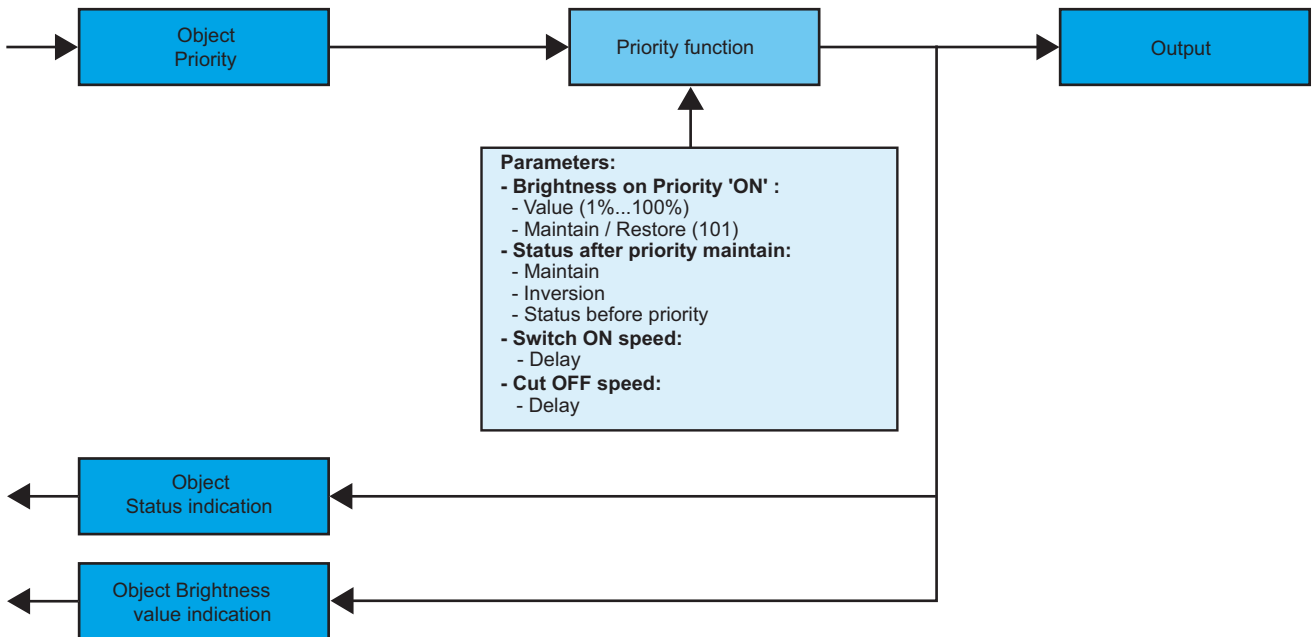

→ Priority function description (EIS priority).

Bit 1	Bit 0
Output behaviour	

Output behaviour	00 = Priority end 01 = Priority end 10 = OFF priority 11 = ON priority
------------------	---

→ Parameters

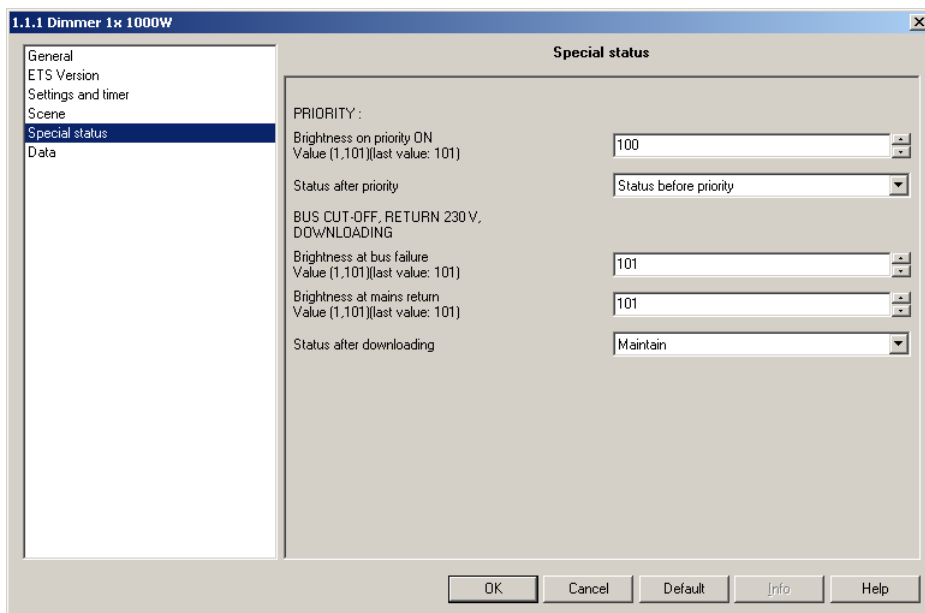

Screen 3

Designation	Description	Values
Brightness on priority ON	This parameter defines the brightness level at priority.	1 % to 100% by steps of 1%, 101. 101 : - If the output is OFF : restoring the lighting level defined by the parameter Brightness at switch ON. - If the output is ON : upholding the level before priority. Default value : 100%.
Status after priority	This parameter defines the brightness level to be applied at the end of the Priority.	Maintain, Inversion, Status before first priority. - Maintain : maintains the output at the status active during Priority. - Inversion : inversion of the output status with regards to the status active during Priority (ON to OFF and OFF to ON). - Status before first priority : switches the output to the status active before the Priority command. Default value : Status before first priority.
Switch ON speed (similar to ON/OFF function)	This parameter defines the dimming speed to reach the brightness level at switching ON.	0 s, 1 s, 2 s, 3 s, 4 s, 5 s, 6 s, 9 s, 15 s, 30 s, 60 s, 2 min, 5 min, 10 min, 20 min, 30 min. Default value : 0 s.
Cut OFF speed (similar to ON/OFF function)	This parameter defines the dimming speed at switching OFF.	0 s, 1 s, 2 s, 3 s, 4 s, 5 s, 6 s, 9 s, 15 s, 30 s, 60 s, 2 min, 5 min, 10 min, 20 min, 30 min. Default value : 0 s.

■ Scene function

A scene allows controlling a group of outputs. Each of the outputs of this group will be put in a status predefined for this scene. A scene is started by the Scene object.

For each scene, the brightness level and the dimming speed to reach it can be defined.

The group of outputs is created previously by establishing the link between the outputs that must belong to the scene and the pushbutton that will trigger the scene. Each output may be integrated in 32 different scenes.

The status of each output may be defined by parameterising or by learning in the room using the pushbuttons of the installation.

A. Configuration and storing by means of parameterising

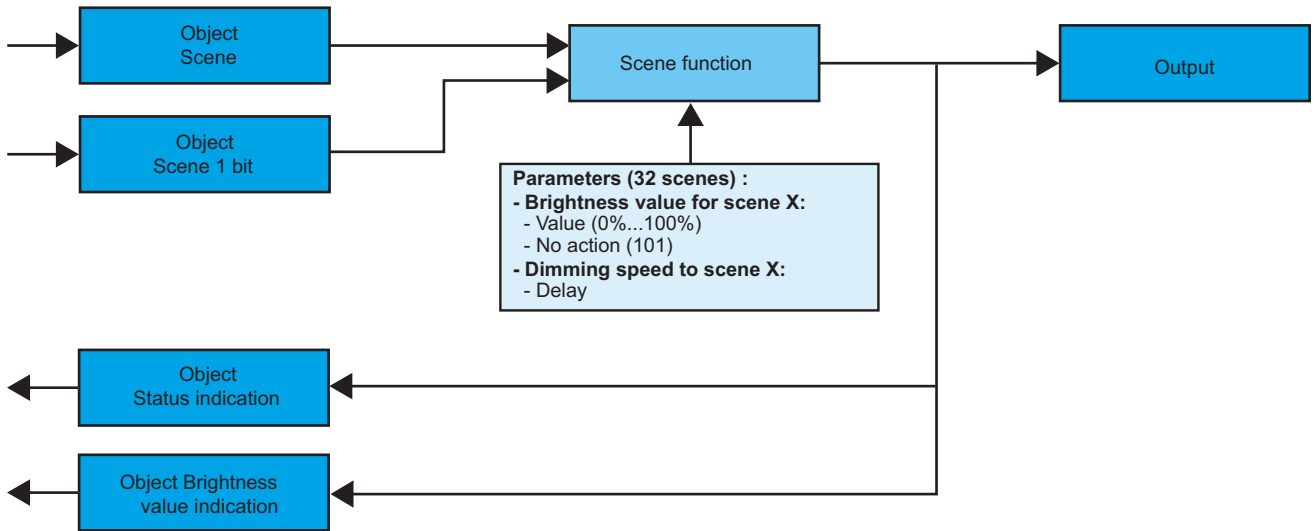

→ Description of scene object (1 byte)

7	6	5	4	3	2	1	0
Learn	X	Scene number					

→ Operating way

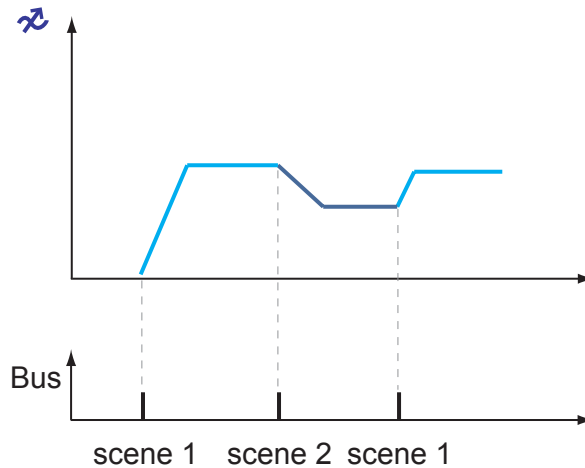

→ Parameters

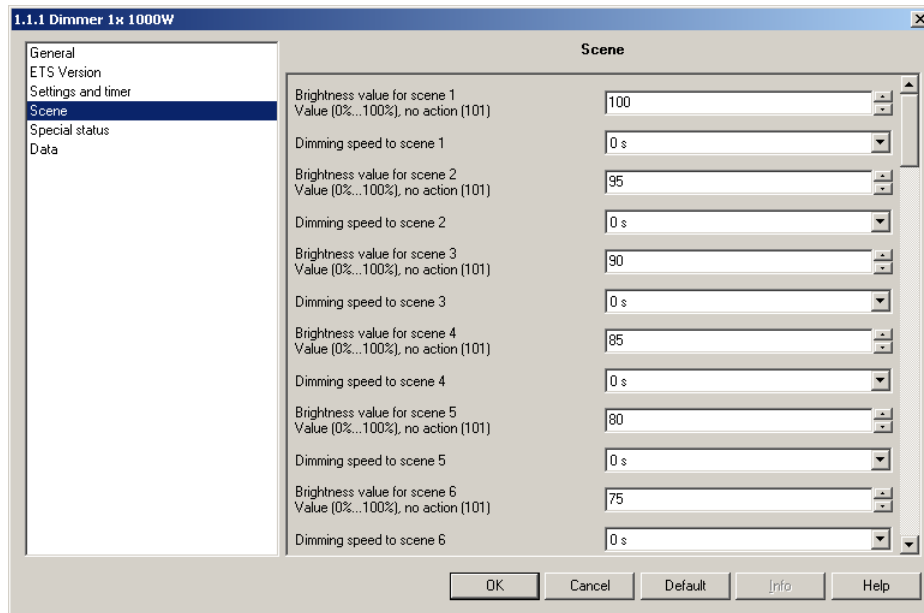

Screen 4

Designation	Description	Values																																
Brightness value for scene X	This parameter defines the status of the output linked with scene X.	0 % to 100% by steps of 1%, 101 (No action). Default value : depends on the scene number. <table border="0" style="width: 100%;"> <tr> <td style="width: 50%;">Scene 1 : 100</td> <td style="width: 50%;">Scene 17 : 20</td> </tr> <tr> <td>Scene 2 : 95</td> <td>Scene 18 : 15</td> </tr> <tr> <td>Scene 3 : 90</td> <td>Scene 19 : 10</td> </tr> <tr> <td>Scene 4 : 85</td> <td>Scene 20 : 5</td> </tr> <tr> <td>Scene 5 : 80</td> <td>Scene 21 : 0</td> </tr> <tr> <td>Scene 6 : 75</td> <td>Scene 22 : 100</td> </tr> <tr> <td>Scene 7 : 70</td> <td>Scene 23 : 90</td> </tr> <tr> <td>Scene 8 : 65</td> <td>Scene 24 : 80</td> </tr> <tr> <td>Scene 9 : 60</td> <td>Scene 25 : 70</td> </tr> <tr> <td>Scene 10 : 55</td> <td>Scene 26 : 60</td> </tr> <tr> <td>Scene 11 : 50</td> <td>Scene 27 : 50</td> </tr> <tr> <td>Scene 12 : 45</td> <td>Scene 28 : 40</td> </tr> <tr> <td>Scene 13 : 40</td> <td>Scene 29 : 30</td> </tr> <tr> <td>Scene 14 : 35</td> <td>Scene 30 : 20</td> </tr> <tr> <td>Scene 15 : 30</td> <td>Scene 31 : 10</td> </tr> <tr> <td>Scene 16 : 25</td> <td>Scene 32 : 0</td> </tr> </table>	Scene 1 : 100	Scene 17 : 20	Scene 2 : 95	Scene 18 : 15	Scene 3 : 90	Scene 19 : 10	Scene 4 : 85	Scene 20 : 5	Scene 5 : 80	Scene 21 : 0	Scene 6 : 75	Scene 22 : 100	Scene 7 : 70	Scene 23 : 90	Scene 8 : 65	Scene 24 : 80	Scene 9 : 60	Scene 25 : 70	Scene 10 : 55	Scene 26 : 60	Scene 11 : 50	Scene 27 : 50	Scene 12 : 45	Scene 28 : 40	Scene 13 : 40	Scene 29 : 30	Scene 14 : 35	Scene 30 : 20	Scene 15 : 30	Scene 31 : 10	Scene 16 : 25	Scene 32 : 0
Scene 1 : 100	Scene 17 : 20																																	
Scene 2 : 95	Scene 18 : 15																																	
Scene 3 : 90	Scene 19 : 10																																	
Scene 4 : 85	Scene 20 : 5																																	
Scene 5 : 80	Scene 21 : 0																																	
Scene 6 : 75	Scene 22 : 100																																	
Scene 7 : 70	Scene 23 : 90																																	
Scene 8 : 65	Scene 24 : 80																																	
Scene 9 : 60	Scene 25 : 70																																	
Scene 10 : 55	Scene 26 : 60																																	
Scene 11 : 50	Scene 27 : 50																																	
Scene 12 : 45	Scene 28 : 40																																	
Scene 13 : 40	Scene 29 : 30																																	
Scene 14 : 35	Scene 30 : 20																																	
Scene 15 : 30	Scene 31 : 10																																	
Scene 16 : 25	Scene 32 : 0																																	
Dimming speed to scene X	This parameter defines the dimming speed to reach the brightness level to be applied for the scene X.	0 s, 1 s, 2 s, 3 s, 5 s, 10 s, 15 s, 20 s, 30 s, 45 s, 1 min, 2 min, 3 min, 4 min, 5 min, 10 min, 15 min, 20 min, 30 min, 45 min, 1 h, 1 h 30 min, 2 h, 2 h 30 min, 3 h, 3 h 30 min, 4 h. Default value : 0 s.																																

B. Learning and storing in the room

This procedure allows modifying and storing a scene by means of local action on the pushbuttons located in the room.

- Activate the scene pressing briefly on the room pushbutton that triggers the scene.
- Set the outputs to the desired status using the pushbuttons that control them individually.
- Store the status of the outputs pressing for more than 5 sec the room pushbutton that triggers the scene.
The storage is indicated by the status inversion of the involved outputs for 3 sec.

■ Special statuses

The parameters grouped in this section allow defining the behaviour of the output in some special cases.

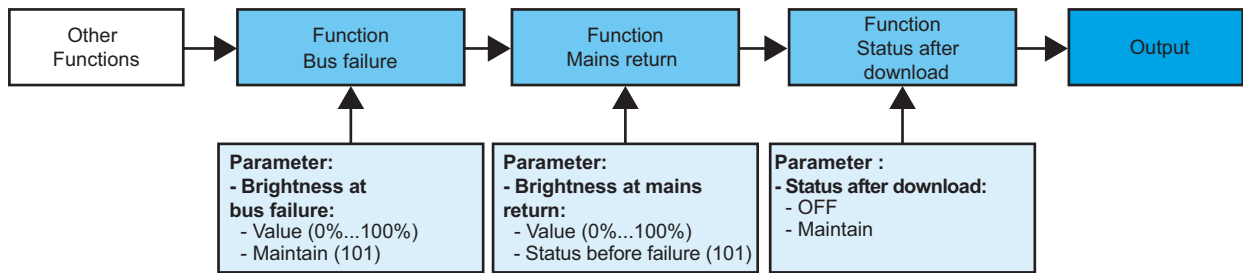

→ Parameters setting screen : see "Screen 3".

→ Parameters

Designation	Description	Values
Brightness at bus failure.	This parameter defines the brightness level to be applied on bus return.	0 % to 100% by steps of 1%, 101 (Maintain). Default value : 101 (Maintain).
Brightness at mains return.	This parameter defines the brightness level to be applied at mains return.	0 % to 100% by steps of 1%, 101 (Status before failure). Default value : 101 (Status before failure).
Status after download	This parameter defines the output status after download.	OFF, Maintain. Default value : Maintain.

3. Main characteristics

Max. number of group addresses	252
Max. number of links	254
Objects	8 total

4. Physical addressing

To perform physical addressing or check for the presence of the bus, press the lighted pushbutton located above the label holder on the right of the product.

Indicator on = bus present and product in physical addressing.

The product remains in physical addressing until the physical address is transmitted by ETS. Pressing a second time allows leaving the physical addressing mode.

Physical addressing may be performed in Auto or in Manual (☞) mode.



NOTA

